

HITACHI

LVP
LITHIUM-ION POWER

DH 52ME • DH 52MEY

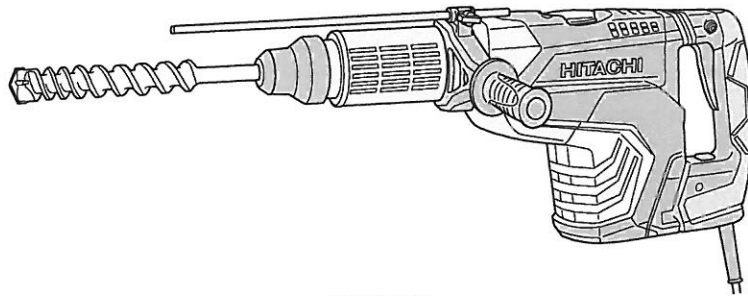

DH52MEY

en

de

fr

it

nl

es

pt

sv

da

no

fi

el

pl

hu

cs

tr

ro

sl

sk

bg

sr

hr

uk

ru



Ⓜ Handling instructions

Ⓜ Bedienungsanleitung

Ⓜ Mode d'emploi

Ⓜ Istruzioni per l'uso

Ⓜ Gebruiksaanwijzing

Ⓜ Instrucciones de manejo

Ⓜ Instruções de uso

Ⓜ Bruksanvisning

Ⓜ Brugsanvisning

Ⓜ Bruksanvisning

Ⓜ Käyttöohjeet

Ⓜ Οδηγίες χειρισμού

Ⓜ Instrukcja obsługi

Ⓜ Kezelési utasítás

Ⓜ Návod k obsluze

Ⓜ Kullanım talimatları

Ⓜ Instruções de utilizare

Ⓜ Navodila za rokovanje

Ⓜ Pokyny na manipuláciu

Ⓜ Инструкция за експлоатация

Ⓜ Uputstvo za rukovanje

Ⓜ Upute za rukovanje

Ⓜ Інструкції щодо поводження з пристроєм

Ⓜ Инструкция по эксплуатации



Hitachi Koki

English

(Original instructions)

GENERAL POWER TOOL SAFETY WARNINGS

⚠ WARNING

Read all safety warnings and all instructions.

Failure to follow the warnings and instructions may result in electric shock, fire and/or serious injury.

Save all warnings and instructions for future reference.

The term "power tool" in the warnings refers to your mains-operated (corded) power tool or battery-operated (cordless) power tool.

- 1) **Work area safety**
 - a) **Keep work area clean and well lit.**
Cluttered or dark areas invite accidents.
 - b) **Do not operate power tools in explosive atmospheres, such as in the presence of flammable liquids, gases or dust.**
Power tools create sparks which may ignite the dust or fumes.
 - c) **Keep children and bystanders away while operating a power tool.**
Distractions can cause you to lose control.
 - 2) **Electrical safety**
 - a) **Power tool plugs must match the outlet. Never modify the plug in any way. Do not use any adapter plugs with earthed (grounded) power tools.**
Unmodified plugs and matching outlets will reduce risk of electric shock.
 - b) **Avoid body contact with earthed or grounded surfaces, such as pipes, radiators, ranges and refrigerators.**
There is an increased risk of electric shock if your body is earthed or grounded.
 - c) **Do not expose power tools to rain or wet conditions.**
Water entering a power tool will increase the risk of electric shock.
 - d) **Do not abuse the cord. Never use the cord for carrying, pulling or unplugging the power tool. Keep cord away from heat, oil, sharp edges or moving parts.**
Damaged or entangled cords increase the risk of electric shock.
 - e) **When operating a power tool outdoors, use an extension cord suitable for outdoor use.**
Use of a cord suitable for outdoor use reduces the risk of electric shock.
 - f) **If operating a power tool in a damp location is unavoidable, use a residual current device (RCD) protected supply.**
Use of an RCD reduces the risk of electric shock.
 - 3) **Personal safety**
 - a) **Stay alert, watch what you are doing and use common sense when operating a power tool. Do not use a power tool while you are tired or under the influence of drugs, alcohol or medication.**
A moment of inattention while operating power tools may result in serious personal injury.
 - b) **Use personal protective equipment. Always wear eye protection.**
Protective equipment such as dust mask, non-skid safety shoes, hard hat, or hearing protection used for appropriate conditions will reduce personal injuries.
 - c) **Prevent unintentional starting. Ensure the switch is in the off position before connecting to power source and/or battery pack, picking up or carrying the tool.**
 - 4) **Power tool use and care**
 - a) **Do not force the power tool. Use the correct power tool for your application.**
The correct power tool will do the job better and safer at the rate for which it was designed.
 - b) **Do not use the power tool if the switch does not turn it on and off.**
Any power tool that cannot be controlled with the switch is dangerous and must be repaired.
 - c) **Disconnect the plug from the power source and/or the battery pack from the power tool before making any adjustments, changing accessories, or storing power tools.**
Such preventive safety measures reduce the risk of starting the power tool accidentally.
 - d) **Store idle power tools out of the reach of children and do not allow persons unfamiliar with the power tool or these instructions to operate the power tool.**
Power tools are dangerous in the hands of untrained users.
 - e) **Maintain power tools. Check for misalignment or binding of moving parts, breakage of parts and any other condition that may affect the power tool's operation. If damaged, have the power tool repaired before use.**
Many accidents are caused by poorly maintained power tools.
 - f) **Keep cutting tools sharp and clean.**
Properly maintained cutting tools with sharp cutting edges are less likely to bind and are easier to control.
 - g) **Use the power tool, accessories and tool bits etc. in accordance with these instructions, taking into account the working conditions and the work to be performed.**
Use of the power tool for operations different from those intended could result in a hazardous situation.
 - 5) **Service**
 - a) **Have your power tool serviced by a qualified repair person using only identical replacement parts.**
This will ensure that the safety of the power tool is maintained.
- CARRYING POWER TOOLS**
Carrying power tools with your finger on the switch or energising power tools that have the switch on invites accidents.
- d) **Remove any adjusting key or wrench before turning the power tool on.**
A wrench or a key left attached to a rotating part of the power tool may result in personal injury.
 - e) **Do not overreach. Keep proper footing and balance at all times.**
This enables better control of the power tool in unexpected situations.
 - f) **Dress properly. Do not wear loose clothing or jewellery. Keep your hair, clothing and gloves away from moving parts.**
Loose clothes, jewellery or long hair can be caught in moving parts.
 - g) **If devices are provided for the connection of dust extraction and collection facilities, ensure these are connected and properly used.**
Use of dust collection can reduce dust-related hazards.
- PRECAUTION**
Keep children and infirm persons away.
When not in use, tools should be stored out of reach of children and infirm persons.

ROTARY HAMMER SAFETY WARNINGS

- Wear ear protectors**
Exposure to noise can cause hearing loss.
- Use auxiliary handle(s), if supplied with the tool.**
Loss of control can cause personal injury.
- Hold power tool by insulated gripping surfaces, when performing an operation where the cutting accessory may contact hidden wiring or its own cord.**
Cutting accessory contacting a "live" wire may make exposed metal parts of the power tool "live" and could give the operator an electric shock.



ADDITIONAL SAFETY WARNINGS

















- Ensure that the power source to be utilized conforms to the power requirements specified on the product nameplate.
- Ensure that the power switch is in the OFF position. If the plug is connected to a receptacle while the power switch is in the ON position, the power tool will start operating immediately, which could cause a serious accident.
- When the work area is removed from the power source, use an extension cord of sufficient thickness and rated capacity. The extension cord should be kept as short as practicable.
- Do not touch the bit during or immediately after operation. The bit becomes very hot during operation and could cause serious burns.
- Before starting to break, chip or drill into a wall, floor or ceiling, thoroughly confirm that such items as electric cables or conduits are not buried inside.
- Always hold the body handle and side handle of the power tool firmly. Otherwise the counterforce produced may result in inaccurate and even dangerous operation.
- Wear a dust mask.
Do not inhale the harmful dusts generated in drilling or chiseling operation. The dust can endanger the health of yourself and bystanders.
- Mounting the tool
 - To prevent accidents, make sure to turn the switch off and disconnect the plug from the receptacle.
 - When using tools such as bull points, drill bits, etc., make sure to use the genuine parts designated by our company.
 - Clean the shank portion of the drill bit. Then smear the shank portion with the grease or machine oil.
- The rotation speed cannot be changed by pressing the rotation speed selector switch while the motor is rotating. To change speeds, switch off the tool first.
- RCD
The use of a residual current device with a rated residual current of 30mA or less at all times is recommended.

SYMBOLS

WARNING

The following show symbols used for the machine. Be sure that you understand their meaning before use.

	DH52ME / DH52MEY: Rotary Hammer
	User Vibration Protection

	Read all safety warnings and all instructions.
	Only for EU countries Do not dispose of electric tools together with household waste material! In observance of European Directive 2002/96/EC on waste electrical and electronic equipment and its implementation in accordance with national law, electric tools that have reached the end of their life must be collected separately and returned to an environmentally compatible recycling facility.
V	Rated voltage
P	Power Input
n_0	No-load speed
Bpm	Full-load impact rate
ϕ max	Drilling diameter, max.
	Weight (According to EPTA-Procedure 01/2003)
	Drill bit
	Core bit
	Adjustment of the tool position function
	Hammering only function
	Rotation and hammering function
	Switching ON
	Switching OFF
	Continuous operation button
	Power lamp
	Rotation speed selector switch
	Display lamp
LS	Low speed / impact rate
Hs	High speed / impact rate
	Disconnect mains plug from electrical outlet
	Class II tool
	SDS max shank

English

STANDARD ACCESSORIES

In addition to the main unit (1 unit), the package contains the accessories listed in the below.

- Plastic case 1
- Side handle 1
- Stopper 1
- Hammer Grease A 1

Standard accessories are subject to change without notice.

APPLICATIONS

Rotation and hammering function 

- Drilling anchor holes
- Drilling holes in concrete

Hammering only function 

- Crushing concrete, chipping, digging, and squaring (by applying optional accessories)

SPECIFICATIONS

The specifications of this machine are listed in the Table on page 105.

NOTE

Due to HITACHI's continuing program of research and development, the specifications herein are subject to change without prior notice.

MOUNTING AND OPERATION

Action	Figure	Page
Inserting SDS-max tools	1	106
Removing SDS-max tools	2	106
Changing tool direction	3	106
Selecting the operating mode	4	106
Switching on and off	5	106
About the power lamp	6	107
Speed change	7	107
Install the stopper	8	107
Using tapershank adapter	9	108
Removing tapershank adapter	10	108
Mounting core bit	11	108
Mounting guide plate and center pin	12	108
Selecting accessories*	-	109, 110

* For detailed information regarding each tool, contact a Hitachi authorized service center.

Warming up (Fig. 13)

The grease lubrication system in this unit may require warming up in cold regions.

Position the end of the bit so makes contact with the concrete, turn on the switch and perform the warming up operation. Make sure that a hitting sound is produced and then use the unit.

CAUTION

When the warming up operation is performed, hold the side handle and the main body securely with both hands to maintain a secure grip and be careful not to twist your body by the jammed drill bit.

Using Continuous operation button

The Continuous operation button feature is only available for "Hammering Mode ". Pressing the Continuous operation button will switch on a blue LED that indicates the activation of the Continuous operation function which will keep the tool running even after the trigger switch is released. To cancel the function, press the Continuous operation button again or push the trigger switch to the ON position. (Fig. 14)

NOTE

Continuous operation will be deactivated when the switch is pressed. During continuous operation, keep your hand away from the switch and grip the lower part of the handle to avoid any unintentional contact with the switch. (Fig.15)





ABOUT THE PROTECTION FUNCTION

This tool has a built-in protection circuit for preventing damage to the unit in the event of an abnormality. Depending on the nature of the abnormality, the display lamp will flash as shown in Table 1 and the unit will cease to operate. In such cases, verify the problem indicated by the flashing and take whatever steps are necessary to correct the problem.

NOTE

Repair may be required if the display lamp continues to flash after taking all necessary steps to correct the problem. If the problem persists, please arrange for repairs.

Table 1

Display lamp flashing	Cause	Solution
	Internal temperature has risen beyond the unit's specified temperature. (Temperature increase protection function)	Turn off the unit and allow it to cool down for about 15 to 30 minutes. When the temperature goes down, press the rotation speed selector switch to recover.
	Excessive pressure applied to the tool has resulted in an overload. (Overload protection function)	Press the rotation speed selector switch to recover. Try to avoid tasks that will apply excess pressure to the unit.
	Tool is connected to a power source whose voltage is either too high or too low. (Circuit protection function)	Connect the unit to a power supply matching the input voltage specified on the nameplate. Press the rotation speed selector switch to recover.
	Sensor signal read error. (Control monitoring function)	Press the rotation speed selector switch to recover. Repair may be required if this error continuously occurs.

GREASE REPLACEMENT

This Rotary Hammer is of full air-tight construction to protect against dust and to prevent lubricant leakage. Therefore, this Rotary Hammer can be used without lubrication for long periods. Replace the grease as described below.

Grease Replacement Period

After purchase, replace grease after every 6 months of usage. Ask for grease replacement at the nearest authorized Service Center.

MAINTENANCE AND INSPECTION

1. Inspecting the drill bits

Since use of a dull tool will cause motor malfunctioning and degraded efficiency, replace the drill bit with new ones or resharpen them without delay when abrasion is noted.

2. Inspecting the mounting screws

Regularly inspect all mounting screws and ensure that they are properly tightened. Should any of the screws be loose, retighten them immediately. Failure to do so could result in serious hazard.

3. Maintenance of the motor

The motor unit winding is the very "heart" of the power tool.

Exercise due care to ensure the winding does not become damaged and/or wet with oil or water.

4. Replacing supply cord

If the replacement of the supply cord is necessary, this has to be done by the manufacturer of this agent in order to avoid a safety hazard.

CAUTION

In the operation and maintenance of power tools, the safety regulations and standards prescribed in each country must be observed.

GUARANTEE

We guarantee Hitachi Power Tools in accordance with statutory/country specific regulation. This guarantee does not cover defects or damage due to misuse, abuse, or normal wear and tear. In case of complaint, please send the Power Tool, undismantled, with the GUARANTEE CERTIFICATE found at the end of this Handling instruction, to a Hitachi Authorized Service Center.

IMPORTANT

Correct connection of the plug

The wires of the main lead are coloured in accordance with the following code:

Blue: — Neutral

Brown: — Live

As the colours of the wires in the main lead of this tool may not correspond with the coloured markings identifying the terminals in your plug proceed as follows:

The wire coloured blue must be connected to the terminal marked with the letter N or coloured black. The wire coloured brown must be connected to the terminal marked with the letter L or coloured red. Neither core must be connected to the earth terminal.

NOTE:

This requirement is provided according to BRITISH STANDARD 2769: 1984.

Therefore, the letter code and colour code may not be applicable to other markets except The United Kingdom.

Information concerning airborne noise and vibration

The measured values were determined according to EN60745 and declared in accordance with ISO 4871.

Measured A-weighted sound power level: 113 dB (A)

Measured A-weighted sound pressure level: 102 dB (A)

Uncertainty K: 3 dB (A).

Wear hearing protection.

Vibration total values (triax vector sum) determined according to EN60745.

Hammer drilling into concrete:

Vibration emission value a_h , HD = 14.0 m/s² (DH52ME)

9.8 m/s² (DH52MEY)

Uncertainty K = 1.5 m/s²

Equivalent chiselling value:

Vibration emission value a_h , CHEq = 15.5 m/s² (DH52ME)

9.7 m/s² (DH52MEY)

Uncertainty K = 1.5 m/s²

The declared vibration total value has been measured in accordance with a standard test method and may be used for comparing one tool with another.

It may also be used in a preliminary assessment of exposure.





WARNING

○ The vibration emission during actual use of the power tool can differ from the declared total value depending in the ways in which the tool is used.

○ Identify safety measures to protect the operator that are based on an estimation of exposure in the actual conditions of use (taking account of all parts of the operating cycle such as the times when the tool is switched off and when it is running idle in addition to the trigger time).

NOTE

Due to HITACHI's continuing program of research and development, the specifications herein are subject to change without prior notice.

	DH52ME	DH52MEY
V	(110 V, 120 V, 127 V, 220 V, 230 V, 240 V) ~	
P	1500 W	
n_0	110 V, 120 V, 127 V : 110 – 260 min ⁻¹ 220 V, 230 V, 240 V : 110 – 280 min ⁻¹	
Bpm	110 V, 120 V, 127 V : 1000 – 2200 min ⁻¹ 220 V, 230 V, 240 V : 1000 – 2400 min ⁻¹	
 ϕ max	52 mm	
 ϕ max	160 mm	
 kg	11,0 kg	11,5 kg

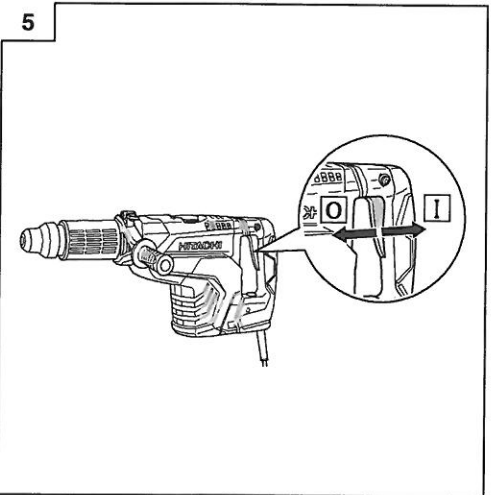
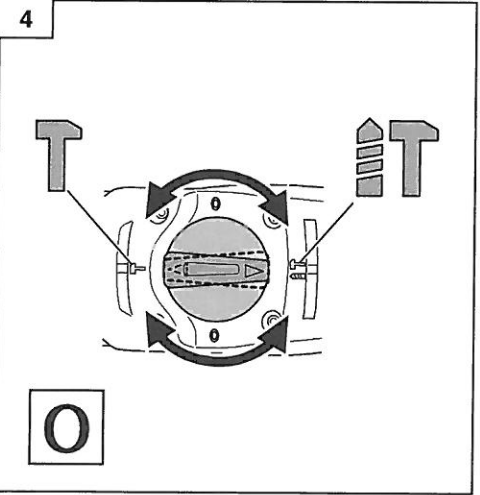
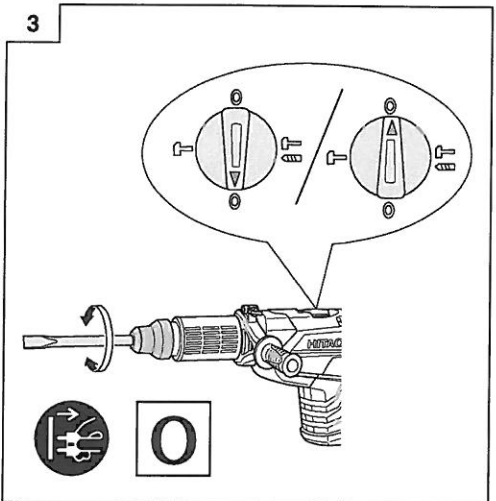
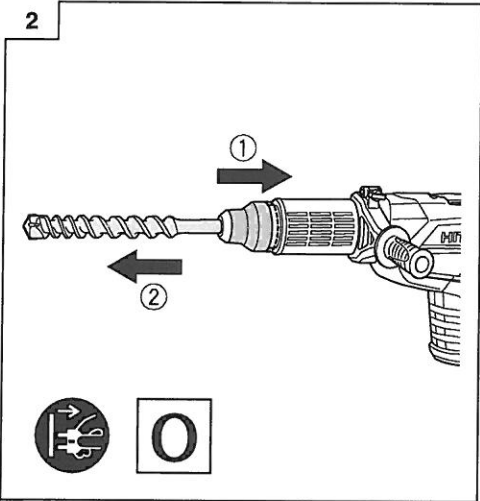
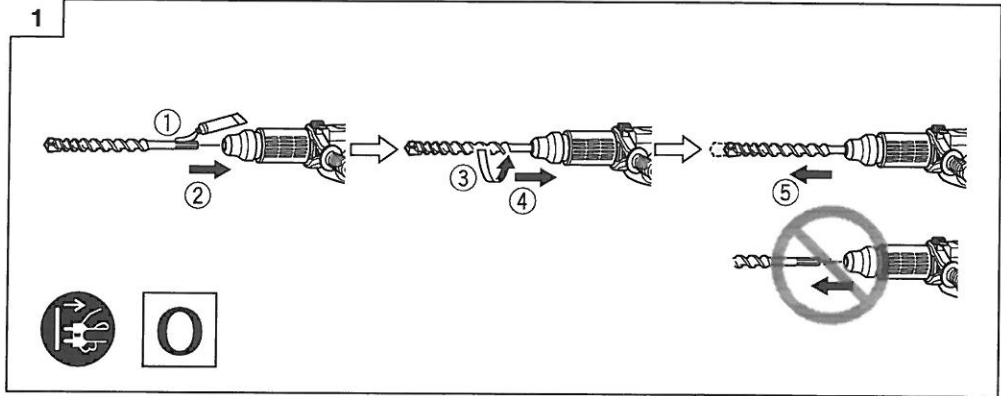

6

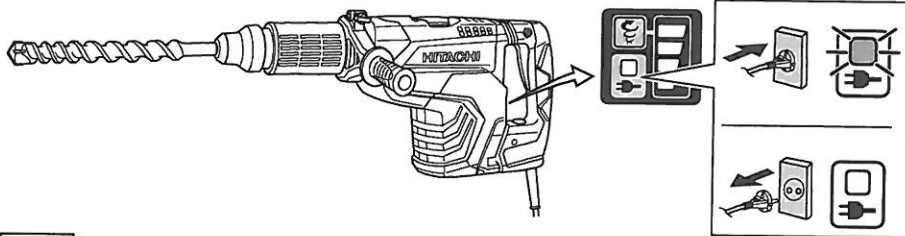

7

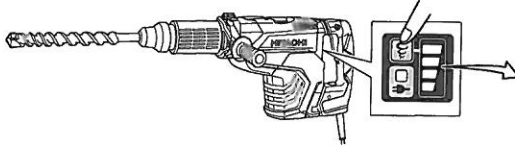

		Ls Hs			
110 V	n_0	110	160	210	260
120 V					
127 V	Bpm	1000	1400	1800	2200
220 V	n_0	110	160	220	280
230 V					
240 V	Bpm	1000	1400	1900	2400

8

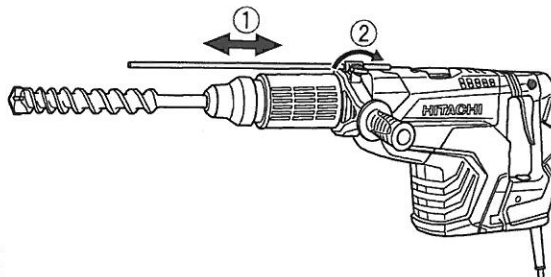

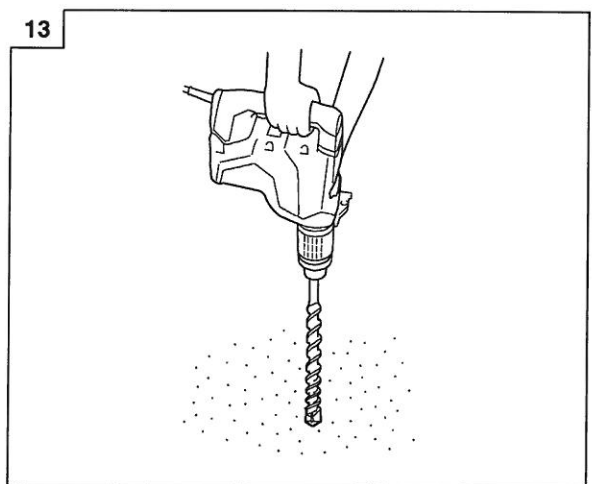
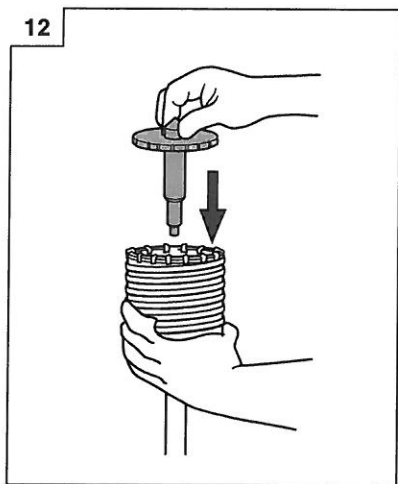
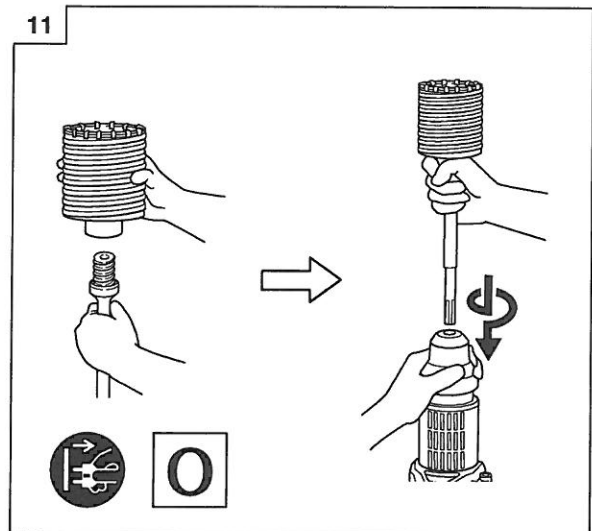
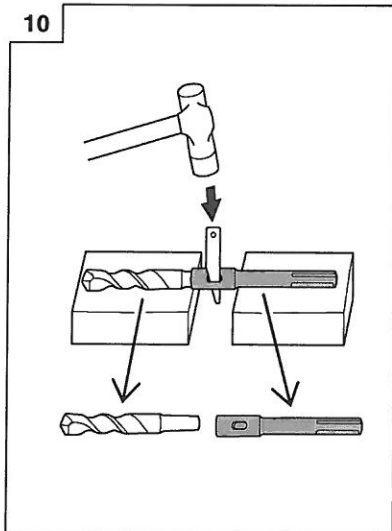
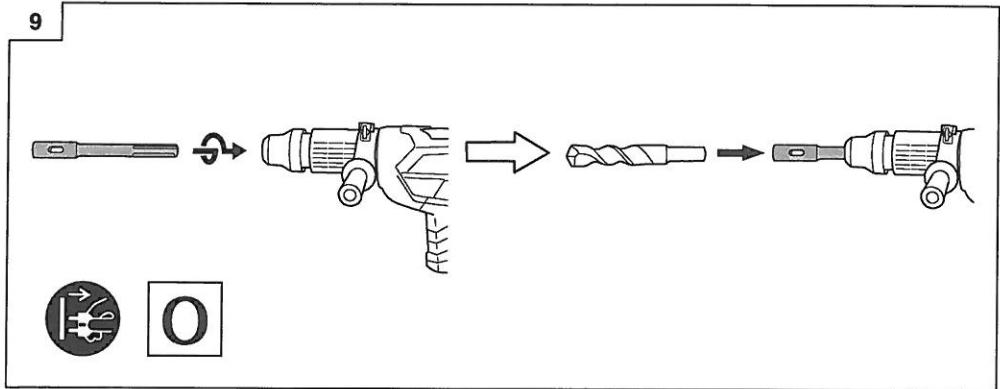

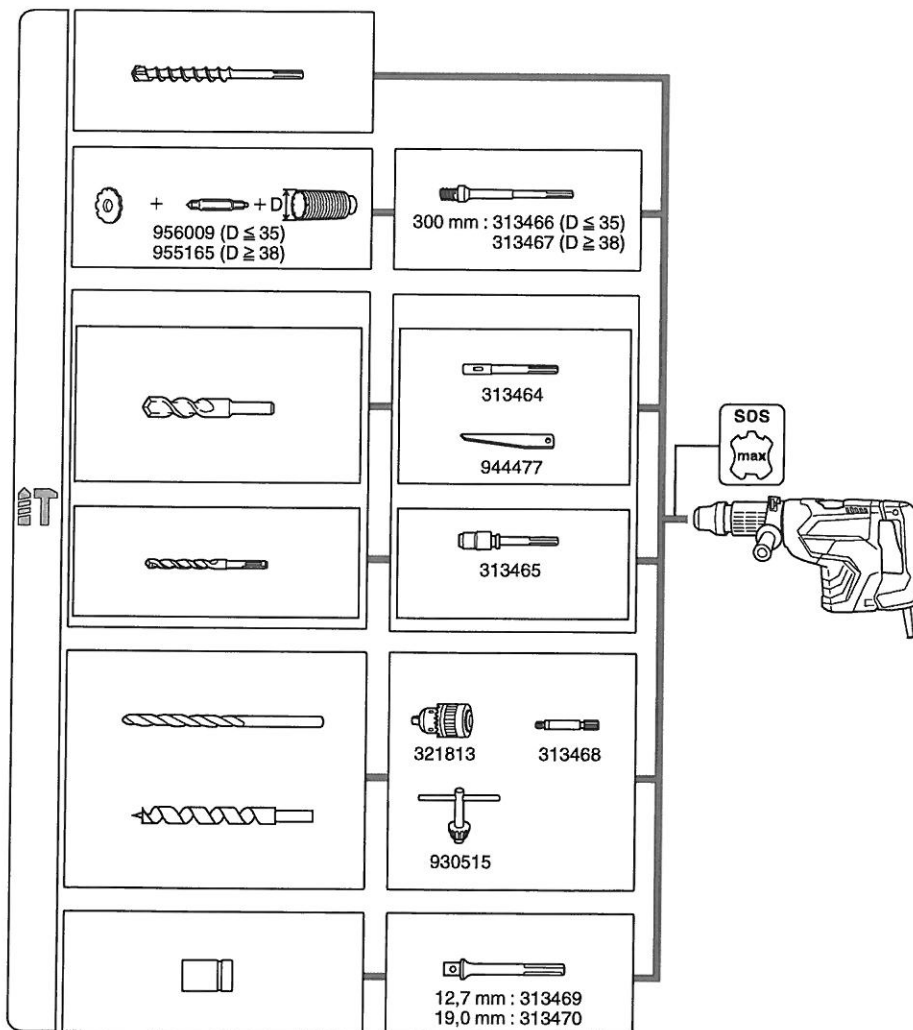
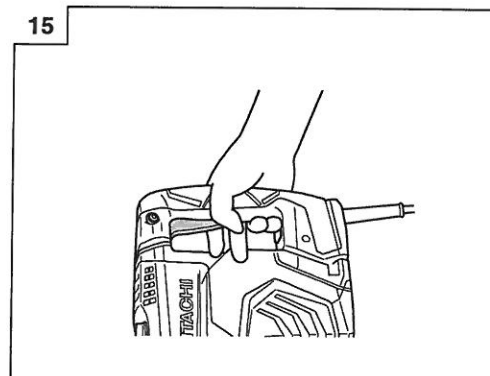
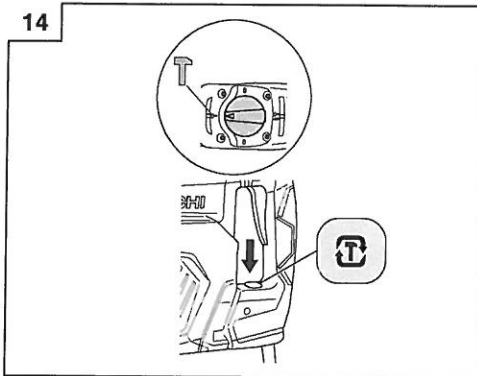

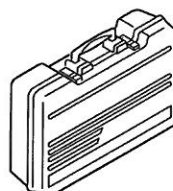
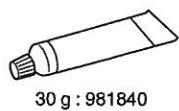
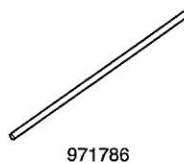
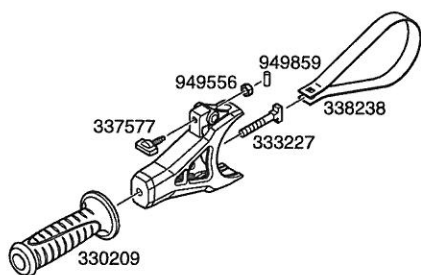
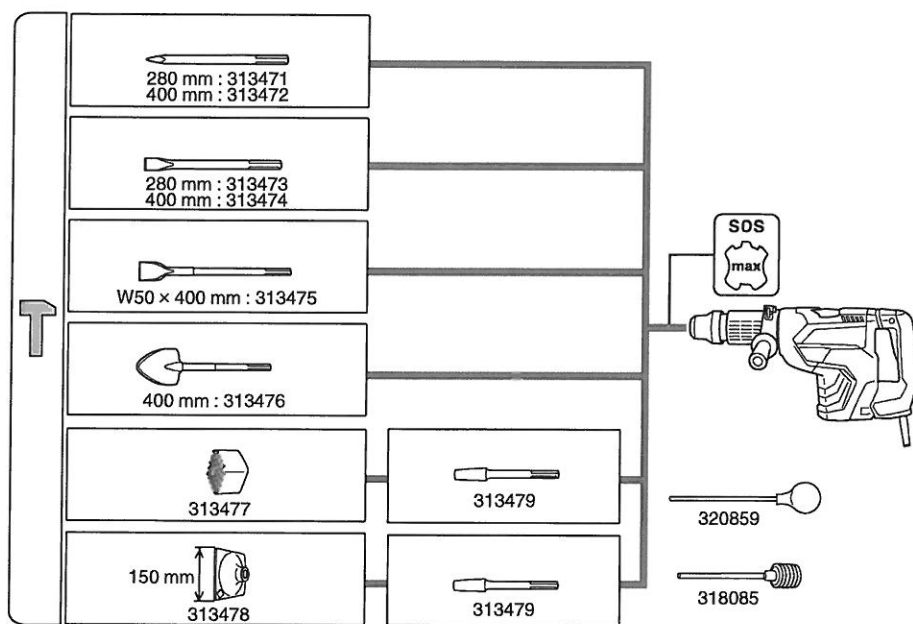

<p>English</p> <p>GUARANTEE CERTIFICATE</p> <p>① Model No. ② Serial No. ③ Date of Purchase ④ Customer Name and Address ⑤ Dealer Name and Address (Please stamp dealer name and address)</p>	<p>Dansk</p> <p>GARANTIBEVIS</p> <p>① Modelnummer ② Serienummer ③ Købsdato ④ Kundes navn og adresse ⑤ Forhandlers navn og adresse (Indsæt stempel med forhandlers navn og adresse)</p>	<p>Română</p> <p>CERTIFICAT DE GARANȚIE</p> <p>① Model nr. ② Nr. de serie ③ Data cumpărării ④ Numele și adresa clientului ⑤ Numele și adresa distribuitorului (Vă rugăm aplicați ștampila cu numele și adresa distribuitorului)</p>
<p>Deutsch</p> <p>GARANTIESCHEIN</p> <p>① Modell-Nr. ② Serien-Nr. ③ Kaufdatum ④ Name und Anschrift des Kunden ⑤ Name und Anschrift des Händlers (Bitte mit Namen und Anschrift des Händlers abstempeln)</p>	<p>Norsk</p> <p>GARANTISERTIFIKAT</p> <p>① Modellnr. ② Serienr. ③ Kjøpsdato ④ Kundens navn og adresse ⑤ Forhandlerens navn og adresse (Vennligst stemple forhandlerens navn og adresse)</p>	<p>Slovenščina</p> <p>GARANČJSKO POTRDILO</p> <p>① Št. modela ② Serijska št. ③ Datum nakupa ④ Ime in naslov kupca ⑤ Ime in naslov prodajalca (Prosimo vtišnite žig z imenom in naslovom prodajalca)</p>
<p>Français</p> <p>CERTIFICAT DE GARANTIE</p> <p>① No. de modèle ② No de série ③ Date d'achat ④ Nom et adresse du client ⑤ Nom et adresse du revendeur (Cachet portant le nom et l'adresse du revendeur)</p>	<p>Suomi</p> <p>TAKUUTODISTUS</p> <p>① Malli nro ② Sarja nro ③ Ostopäivämäärä ④ Asiakkaan nimi ja osoite ⑤ Myyjän nimi ja osoite (Leimaa myyjän nimi ja osoite)</p>	<p>Slovenčina</p> <p>ZÁRUČNÝ LISTA</p> <p>① Č. modelu ② Sériové č. ③ Dátum zakúpenia ④ Meno a adresa zákazníka ⑤ Názov a adresa predajcu (Pečiatka s názvom a adresou predajcu)</p>
<p>Italiano</p> <p>CERTIFICATO DI GARANZIA</p> <p>① Modello ② N° di serie ③ Data di acquisto ④ Nome e indirizzo dell'acquirente ⑤ Nome e indirizzo del rivenditore (Si prega di apporre il timbro con questi dati)</p>	<p>Ελληνικά</p> <p>ΠΙΣΤΟΠΟΙΗΤΙΚΟ ΕΓΓΥΗΣΗΣ</p> <p>① Αρ. Μοντέλου ② Αύξων Αρ. ③ Ημερομηνία αγοράς ④ Όνομα και διεύθυνση πελάτη ⑤ Όνομα και διεύθυνση μεταπωλητή (Παρακαλούμε να χρησιμοποιηθεί σφραγίδα)</p>	<p>Български</p> <p>ГАРАНЦИОНЕН СЕРТИФИКАТ</p> <p>① Модел № ② Серийен № ③ Дата за закупуване ④ Име и адрес на клиента ⑤ Име и адрес на търговеца (Моля, отпечатайте името и адрес на дилъра)</p>
<p>Nederlands</p> <p>GARANTIEBEWIJS</p> <p>① Modelnummer ② Serienummer ③ Datum van aankoop ④ Naam en adres van de gebruiker ⑤ Naam en adres van de handelaar (Stempel a.u.b. naam en adres vande handelaar)</p>	<p>Polski</p> <p>GWARANCJA</p> <p>① Model ② Numer seryjny ③ Data zakupu ④ Nazwa klienta i adres ⑤ Nazwa dealera i adres (Pieczęć punktu sprzedaży)</p>	<p>Srpski</p> <p>GARANTNI SERTIFIKAT</p> <p>① Br. modela. ② Serijski br. ③ Datum kupovine ④ Ime i adresa kupca ⑤ Ime i adresa prodavca (Molimo da stavite pečat na ime i adresu trgovca)</p>
<p>Español</p> <p>CERTIFICADO DE GARANTÍA</p> <p>① Número de modelo ② Número de serie ③ Fecha de adquisición ④ Nombre y dirección del cliente ⑤ Nombre y dirección del distribuidor (Se ruega poner el sello del distribuidor con su nombre y dirección)</p>	<p>Magyar</p> <p>GARANCIA BIZONYLAT</p> <p>① Típuszám ② Sorozatszám ③ A vásárlás dátuma ④ A Vásárló neve és címe ⑤ A Kereskedő neve és címe (Kérjük ide elhelyezni a Kereskedő nevének és címének pecsétjét)</p>	<p>Hrvatski</p> <p>JAMSTVENI CERTIFIKAT</p> <p>① Br modela. ② Serijski br. ③ Datum kupnje ④ Ime i adresa kupca ⑤ Ime i adresa trgovca (Molimo stavite pečat na ime i adresu trgovca)</p>
<p>Português</p> <p>CERTIFICADO DE GARANTIA</p> <p>① Número do modelo ② Número do série ③ Data de compra ④ Nome e morada do cliente ⑤ Nome e morada do distribuidor (Por favor, carimbe o nome e morada do distribuidor)</p>	<p>Čeština</p> <p>ZÁRUČNÍ LIST</p> <p>① Model č. ② Série č. ③ Datum nákupu ④ Jméno a adresa zákazníka ⑤ Jméno a adresa prodejce (Prosíme o razliko se jménem a adresou prodejce)</p>	<p>Український</p> <p>ГАРАНТІЙНИЙ СЕРТИФІКАТ</p> <p>① № моделі ② № серії ③ Дата придбання ④ Ім'я і адреса клієнта ⑤ Ім'я і адреса дилера (Будь ласка, поставте печатку з іменем і адресою дилера)</p>
<p>Svenska</p> <p>GARANTICERTIFIKAT</p> <p>① Modellnr ② Serienr ③ Inköpsdatum ④ Kundens namn och adress ⑤ Försäljarens namn och adress (Stämpla försäljarens namn och adress)</p>	<p>Türkçe</p> <p>GARANTİ SERTİFİKASI</p> <p>① Model No. ② Seri No. ③ Satın Alma Tarihi ④ Müşteri Adı ve Adresi ⑤ Bayi Adı ve Adresi (Lütfen bayi adını ve adresini kaşe olarak basın)</p>	<p>Русский</p> <p>ГАРАНТИЙНЫЙ СЕРТИФИКАТ</p> <p>① Модель № ② Серийный № ③ Дата покупки ④ Название и адрес заказчика ⑤ Название и адрес дилера (Пожалуйста, внесите название и адрес дилера)</p>



HITACHI

①	
②	
③	
④	
⑤	

Hitachi Power Tools Europe GmbH

Siemensring 34, 47877 Willich, Germany
Tel: +49 2154 49930
Fax: +49 2154 499350
URL: <http://www.hitachi-powertools.de>

Hitachi Power Tools Netherlands B. V.

Brabanthaven 11, 3433 PJ Nieuwegein, The Netherlands
Tel: +31 30 6084040
Fax: +31 30 6067266
URL: <http://www.hitachi-powertools.nl>

Hitachi Power Tools (U. K.) Ltd.

Precedent Drive, Rooksley, Milton Keynes, MK 13, 8PJ, United Kingdom
Tel: +44 1908 660663
Fax: +44 1908 606642
URL: <http://www.hitachi-powertools.co.uk>

Hitachi Power Tools France S. A. S.

Parc de l'Eglantier 22, rue des Cerisiers, Lisses-C.E. 1541, 91015 EVRY CEDEX, France
Tel: +33 1 69474949
Fax: +33 1 60861416
URL: <http://www.hitachi-powertools.fr>

Hitachi Power Tools Belgium N.V. / S.A.

Koningin Astridlaan 51, B-1780 Wommel, Belgium
Tel: +32 2 460 1720
Fax: +32 2 460 2542
URL: <http://www.hitachi-powertools.be>

Hitachi Fercad Power Tools Italia S.p.A

Via Retrone 49, 36077, Altavilla Vicentina (VI), Italy
Tel: +39 0444 548111
Fax: +39 0444 548110
URL: <http://www.hitachi-powertools.it>

Hitachi Power Tools Iberica, S.A.

Puigbarra, 26-28 Pol. Ind. Can Petit 08227 TERRASSA (Barcelona) Spain
Tel: +34 93 735 6722
Fax: +34 93 735 7442
URL: <http://www.hitachi-powertools.es>

Hitachi Power Tools Österreich GmbH

Str. 7, Objekt 58/A6, Industriezentrum NÖ – Süd 2355 Wiener Neudorf, Austria
Tel: +43 2236 64673/5
Fax: +43 2236 63373
URL: <http://www.hitachi-powertools.at/>

Hitachi Power Tools Norway AS

Kjeller Vest 7, N-2007 Kjeller, Norway
Tel: (+47) 6692 6600
Fax: (+47) 6692 6650
URL: <http://www.hitachi-powertools.no>

Hitachi Power Tools Sweden AB

Rotebergsvagen 2B SE-192 78 Sollentuna, Sweden
Tel: (+46) 8 598 999 00
Fax: (+46) 8 598 999 40
URL: <http://www.hitachi-powertools.se>

Hitachi Power Tools Denmark A/S

Lillebaeltsvej 90, 6715 Esbjerg N, Denmark
Tel: (+45) 75 14 32 00
Fax: (+45) 75 14 36 66
URL: <http://www.hitachi-powertools.dk>

Hitachi Power Tools Finland Oy

Tupalankatu 9, 15680 Lahti, Finland
Tel: (+358) 20 7431 530
Fax: (+358) 20 7431 531
URL: <http://www.hitachi-powertools.fi>

Hitachi Power Tools Hungary Kft.

1106 Bogancsvirag U.5-7, Budapest, Hungary
Tel: +36 1 2643433
Fax: +36 1 2643429
URL: <http://www.hitachi-powertools.hu>

Hitachi Power Tools Polska Sp.z o.o.

ul. Gierdziejewskiego 1
02-495 Warszawa, Poland
Tel: +48 22 863 33 78
Fax: +48 22 863 33 82
URL: <http://www.hitachi-narzedzia.pl/>

Hitachi Power Tools Czech s.r.o.



Modricka 205, 664, 48, Moravany, Czech, Republic
Tel: +420 547 422 660
Fax: +420 547 213 588
URL: <http://www.hitachi-powertools.cz>



Hitachi Power Tools Netherlands B.V.**Moscow Branch**

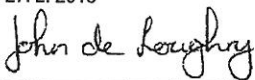

Kashirskoye Shosse Dom 65, 4F
115583 Moscow, Russia
Tel: +7 495 727 4460
Fax: +7 495 727 4461
URL: <http://www.hitachi-pt.ru>

Hitachi Power Tools Romania S. R. L.

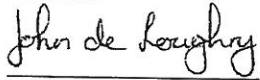
Bld. Biruintei, Nr. 101, Oras Pentelimon, 077145, Judetul Ilfov, ROMANIA
Tel: +031 805 27 19
Fax: +031 805 25 77

<p>English</p> <p>Object of declaration: Hitachi Rotary Hammer DH52ME, DH52MEY</p> <p>EC DECLARATION OF CONFORMITY</p> <p>We declare under our sole responsibility that this product is in conformity with standards or standardization documents EN60745-1, EN60745-2-6, EN55014-1, EN55014-2, EN61000-3-2 and EN61000-3-3 in accordance with Directives 2004/108/EC and 2006/42/EC. This product also conforms to RoHS Directive 2011/65/EU.</p> <p>The European Standards Manager at Hitachi Koki Europe Ltd. is authorized to compile the technical file.</p> <p>This declaration is applicable to the product affixed CE marking.</p>	<p>Nederlands</p> <p>Onderwerp van verklaring: Hitachi Boorhamer DH52ME, DH52MEY</p> <p>EC VERKLARING VAN CONFORMITEIT</p> <p>Wij verklaren onder eigen verantwoordelijkheid dat dit product conform de richtlijnen of gestandaardiseerde documenten EN60745-1, EN60745-2-6, EN55014-1, EN55014-2, EN61000-3-2 en EN61000-3-3 voldoet aan de eisen van bepalingen 2004/108/EC en 2006/42/EC. Dit product voldoet ook aan de RoHS-richtlijn 2011/65/EU.</p> <p>De manager voor Europese normen van Hitachi Koki Europe Ltd. heeft de bevoegdheid tot het samenstellen van het technische bestand.</p> <p>Deze verklaring is van toepassing op producten voorzien van de CE-markeringen.</p>
<p>Deutsch</p> <p>Gegenstand der Erklärung: Hitachi Bohrhämmer DH52ME, DH52MEY</p> <p>EG-KONFORMITÄTSERKLÄRUNG</p> <p>Wir erklären mit alleiniger Verantwortung, dass dieses Produkt den Standards oder Standardisierungsdokumenten EN60745-1, EN60745-2-6, EN55014-1, EN55014-2, EN61000-3-2 und EN61000-3-3 in Übereinstimmung mit den Direktiven 2004/108/EG und 2006/42/EG entspricht. Dieses Produkt stimmt auch mit der RoHS-Richtlinie 2011/65/EU überein.</p> <p>Der Manager für europäische Standards bei der Hitachi Koki Europe Ltd. ist zum Verfassen der technischen Datei befugt.</p> <p>Diese Erklärung gilt für Produkte, die die CE-Markierung tragen.</p>	<p>Español</p> <p>Objeto de declaración: Hitachi Martillo perforador DH52ME, DH52MEY</p> <p>DECLARACIÓN DE CONFORMIDAD DE LA CE</p> <p>Declaramos bajo nuestra única responsabilidad que este producto está de acuerdo con las normas o con los documentos de normalización EN60745-1, EN60745-2-6, EN55014-1, EN55014-2, EN61000-3-2 y EN61000-3-3, según indican las Directivas 2004/108/CE y 2006/42/CE. Este producto satisface también los requisitos establecidos por la Directiva 2011/65/EU (RoHS).</p> <p>El Jefe de Normas Europeas de Hitachi Koki Europe Ltd. está autorizado para recopilar archivos técnicos.</p> <p>Esta declaración se aplica a los productos con marcas de la CE.</p>
<p>Français</p> <p>Objet de la déclaration: Hitachi Marteau perforateur DH52ME, DH52MEY</p> <p>DECLARATION DE CONFORMITE CE</p> <p>Nous déclarons sous notre seule et entière responsabilité que ce produit est conforme aux normes ou documents de normalisation EN60745-1, EN60745-2-6, EN55014-1, EN55014-2, EN61000-3-2 et EN61000-3-3 en accord avec les Directives 2004/108/CE et 2006/42/CE. Ce produit est aussi conforme à la Directive RoHS 2011/65/EU.</p> <p>Le responsable des normes européennes d'Hitachi Koki Europe Ltd. est autorisé à compiler les données techniques.</p> <p>Cette déclaration s'applique aux produits désignés CE.</p>	<p>Português</p> <p>Objeto de declaração: Hitachi Martelo perfurador DH52ME, DH52MEY</p> <p>DECLARAÇÃO DE CONFORMIDADE CE</p> <p>Declaramos, sob nossa única e inteira responsabilidade, que este produto está de acordo com as normas ou documentos normativos EN60745-1, EN60745-2-6, EN55014-1, EN55014-2, EN61000-3-2 e EN61000-3-3, em conformidade com as Directivas 2004/108/CE e 2006/42/CE. Este produto está também em conformidade com a Directiva RoHS 2011/65/EU.</p> <p>O Gestor de Normas Europeias da Hitachi Koki Europe Ltd. está autorizado a compilar o ficheiro técnico.</p> <p>Esta declaração se aplica aos produtos designados CE.</p>
<p>Italiano</p> <p>Oggetto della dichiarazione: Hitachi Martello perforatore DH52ME, DH52MEY</p> <p>DICHIARAZIONE DI CONFORMITÀ CE</p> <p>Dichiariamo sotto nostra responsabilità che questo prodotto è conforme agli standard o ai documenti sulla standardizzazione EN60745-1, EN60745-2-6, EN55014-1, EN55014-2, EN61000-3-2 e EN61000-3-3 in conformità alle Direttive 2004/108/CE e 2006/42/CE. Il prodotto è inoltre conforme alla direttiva RoHS 2011/65/EU.</p> <p>Il Responsabile delle Norme Europee di Hitachi Koki Ltd. è autorizzato a compilare la scheda tecnica.</p> <p>Questa dichiarazione è applicabile ai prodotti cui sono applicati i marchi CE.</p>	<p>Svenska</p> <p>Objekt för deklaration: Hitachi Borrhämmare DH52ME, DH52MEY</p> <p>EF-DEKLARATION BETRÄFFANDE LIFFORMIGHET</p> <p>Vi tillkännagiver med eget ansvar att denna produkt överensstämmer med standard eller standardiserings dokument EN60745-1, EN60745-2-6, EN55014-1, EN55014-2, EN61000-3-2 och EN61000-3-3 i enlighet med direktiven 2004/108/EF och 2006/42/EF. Denna produkt efterlever även RoHS-direktiv 2011/65/EU.</p> <p>Den europeiska standardansvarige på Hitachi Koki Europe Ltd. är auktoriserad att utarbeta den tekniska filen.</p> <p>Denna deklaration gäller för CE-märkningen på produkten.</p>
<p>Hitachi Koki Europe Ltd. Clonsbaugh Business & Technology Park, Dublin 17, Ireland</p> <p>Representative office in Europe Hitachi Power Tools Europe GmbH Siemensring 34, 47877 Willich 1, F. R. Germany</p> <p>Head office in Japan Hitachi Koki Co., Ltd. Shinagawa Intercity Tower A, 15-1, Konan 2-chome, Minato-ku, Tokyo, Japan</p> <p style="text-align: right;">  27. 2. 2015  John de Loughry European Standard Manager 27. 2. 2015  A. Yoshida Vice-President & Director </p>	

<p>Dansk</p> <p>Genstand for erklæring: Hitachi Borehammer DH52ME, DH52MEY</p> <p>EF-OVERENSSTEMMELSESERKLÆRING</p> <p>Vi erklærer os fuldstændige ansvarlige for, at dette produkt modsvarer gældende standard eller standardiserings dokumenter EN60745-1, EN60745-2-6, EN55014-1, EN55014-2, EN61000-3-2 og EN61000-3-3 i overensstemmelse med direktiver 2004/108/EF og 2006/42/EF. Dette produkt er også i overensstemmelse med RoHS direktiv 2011/65/EU.</p> <p>Chefen for europæiske standarder hos Hitachi Koki Europe Ltd. er autoriseret til at compilere den tekniske fil.</p> <p>Denne erklæring gælder produkter, der er mærket med CE.</p>	<p>Polski</p> <p>Przedmiot deklaracji: Hitachi Młotowiertarka DH52ME, DH52MEY</p> <p>DEKLARACJA ZGODNOŚCI Z EC</p> <p>Oznajmiamy z całkowitą odpowiedzialnością, że produkt ten jest zgodny ze standardami lub standardowymi dokumentami EN60745-1, EN60745-2-6, EN55014-1, EN55014-2, EN61000-3-2 i EN61000-3-3 w zgodzie z Zasadami 2004/108/EC i 2006/42/EC. Ten produkt spełnia także wymagania Dyrektywy RoHS 2011/65/EU.</p> <p>Menedżer Standardów Europejskich w firmie Hitachi Koki Europe Ltd. Jest upoważniony do kompilowania pliku technicznego.</p> <p>To oświadczenie odnosi się do załączonego produktu z oznaczeniami CE.</p>
<p>Norsk</p> <p>Erklæringens objekt: Hitachi Elektrisk slagboremaskin DH52ME, DH52MEY</p> <p>EF'S ERKLÆRING OM OVERENSSTEMMELSE</p> <p>Vi erklærer herved at vi påtar oss det fulle ansvar for at dette produktet er i overensstemmelse med normer eller standardiseringsdokumentene EN60745-1, EN60745-2-6, EN55014-1, EN55014-2, EN61000-3-2 og EN61000-3-3 i samsvar med direktivene 2004/108/EF og 2006/42/EF. Dette produktet er også i samsvar med RoHS-direktivet 2011/65/EU.</p> <p>Lederen for europeiske standarder ved Hitachi Koki Europe Ltd. har fullmakt til å utarbeide det tekniske dokumentet.</p> <p>Denne erklæringen gjelder produktets påklistede CE-merking.</p>	<p>Magyar</p> <p>Megfelelőségi nyilatkozat: Hitachi Fúrókalapács DH52ME, DH52MEY</p> <p>EK MEGFELELŐSÉGI NYILATKOZAT</p> <p>Teljes felelősségünk tudatában kijelentjük, hogy ez a termék megfelel az EN60745-1, EN60745-2-6, EN55014-1, EN55014-2, EN61000-3-2 és EN61000-3-3 szabványoknak illetve szabványosítási dokumentumoknak, az Európa Tanács 2004/108/EK és 2006/42/EK Direktíváival összhangban. Ez a termék is megfelel a 2011/65/EU RoHS irányelvnek.</p> <p>Az Hitachi Koki Europe Ltd. Európai Szabványkezelője fel van hatalmazva a műszaki fájll elkészítésére.</p> <p>Jelen nyilatkozat a terméken feltüntetett CE jelzésre vonatkozik.</p>
<p>Suomi</p> <p>Ilmoituksen kohde: Hitachi Poravasara DH52ME, DH52MEY</p> <p>EY-ILMOITUS YHDENMUKAISUUDESTA</p> <p>Yksinomaisella vastuudella vakuutamme, että tämä tuote vastaa tai normitettuja dokumentteja EN60745-1, EN60745-2-6, EN55014-1, EN55014-2, EN61000-3-2 ja EN61000-3-3 ohjeiden 2004/108/EY ja 2006/42/EY mukaisesti. Tämä tuote on myös RoHS-direktiivin (2011/65/EU) mukainen.</p> <p>Hitachi Koki Europe Ltd.:n eurooppalaisten standardien johtaja on valtuutettu laatimaan tekniset asiakirjat.</p> <p>Tämä ilmoitus sovelletaan tuotekohtaiseen CE-merkintään.</p>	<p>Čeština</p> <p>Předmět prohlášení: Hitachi Vrtací kladivo DH52ME, DH52MEY</p> <p>PROHLÁŠENÍ O SHODĚ S CE</p> <p>Prohlašujeme na svoji zodpovědnost, že tento výrobek odpovídá normám EN60745-1, EN60745-2-6, EN55014-1, EN55014-2, EN61000-3-2 a EN61000-3-3 v souladu se směrnicemi 2004/108/EC a 2006/42/EC. Tento výrobek je rovněž v souladu se směrnicí RoHS 2011/65/EU.</p> <p>Vedoucí pracovník pro Evropské normy v Hitachi Koki Europe Ltd. je oprávněný ke zpracování technického souboru.</p> <p>Toto prohlášení platí pro výrobek označený značkou CE.</p>
<p>Ελληνικά</p> <p>Αντικείμενο δήλωσης: Hitachi Σφυροδράπανο περιστροφικό DH52ME, DH52MEY</p> <p>ΕΚ ΔΗΛΩΣΗ ΕΝΑΡΜΟΝΙΣΜΟΥ</p> <p>Δηλώνουμε με απόλυτη υπευθυνότητα ότι αυτό το προϊόν είναι εναρμονισμένο με τα πρότυπα ή τα έγγραφα δημιουργίας προτύπων EN60745-1, EN60745-2-6, EN55014-1, EN55014-2, EN61000-3-2 και EN61000-3-3 σε συμφωνία με τις Οδηγίες 2004/108/EK και 2006/42/EK. Αυτό το προϊόν συμμορφώνεται επίσης με την οδηγία RoHS 2011/65/EU.</p> <p>Ο υπεύθυνος για τα ευρωπαϊκά πρότυπα στην Hitachi Koki Europe Ltd. είναι εξουσιοδοτημένος να συντάσσει τον τεχνικό φάκελο.</p> <p>Αυτή η δήλωση ισχύει στο προϊόν με το σημάδι CE.</p>	<p>Türkçe</p> <p>Beyan konusu: Hitachi Kirici delici DH52ME, DH52MEY</p> <p>AB UYGUNLUK BEYANI</p> <p>Bu ürünün, 2004/108/EC, 2006/42/EC sayılı Direktiflerine uygun olarak EN60745-1, EN60745-2-6, EN55014-1, EN55014-2, EN61000-3-2 ve EN61000-3-3 sayılı standartlara ve standardizasyon belgelerine uygun olduğunu, tamamen kendi sorumluluğumuz altında beyan ederiz. Bu ürün, ayrıca RoHS Yönergesi 2011/65/EU'ya uygundur.</p> <p>Hitachi Koki Europe Ltd. Avrupa Standartlar Müdürlüğü, teknik dosyayı hazırlama yetkisine sahiptir.</p> <p>Bu beyan, üzerinde CE işareti bulunan ürünler için geçerlidir.</p>
<p>Hitachi Koki Europe Ltd. Clonsbaugh Business & Technology Park, Dublin 17, Ireland</p> <p>Representative office in Europe Hitachi Power Tools Europe GmbH Siemensring 34, 47877 Willich 1, F. R. Germany</p> <p>Head office in Japan Hitachi Koki Co., Ltd. Shinagawa Intercity Tower A, 15-1, Konan 2-chome, Minato-ku, Tokyo, Japan</p> <p> 27. 2. 2015</p> <p> John de Loughry European Standard Manager 27. 2. 2015</p> <p> A. Yoshida Vice-President & Director</p>	

<p>Română</p> <p>Obiectul declarației: Hitachi Ciocan rotopercurtor DH52ME, DH52MEY</p> <p>DECLARAȚIE DE CONFORMITATE CE</p> <p>Declarăm pe propria răspundere că acest produs este conform cu standardele sau documentele de standardizare EN60745-1, EN60745-2-6, EN55014-1, EN55014-2, EN61000-3-2 și EN61000-3-3 și cu Directivele 2004/108/CE și 2006/42/CE. Acest produs este, de asemenea, conform cu Directiva RoHS 2011/65/EU.</p> <p>Managerul pentru standarde europene al Hitachi Koki Europe Ltd. este autorizat să întocmească fișa tehnică.</p> <p>Prezenta declarație se referă la produsul pe care este aplicat semnul CE.</p>	<p>Srpski</p> <p>Predmet deklaracije: Hitachi Rotacioni čekić DH52ME, DH52MEY</p> <p>EC DEKLARACIJA O SAOBRAZNOSTI</p> <p>Pod punom odgovornošću izjavljujemo da je ovaj proizvod usklađen s normama i dokumentima za standardizaciju EN60745-1, EN60745-2-6, EN55014-1, EN55014-2, EN61000-3-2 i EN61000-3-3 shodno Direktivama 2004/108/EC i 2006/42/EC. Ovaj proizvod je takođe usklađen sa RoHS Direktivom 2011/65/EU.</p> <p>Direktor za evropske standarde u kompaniji Hitachi Koki Europe Ltd. ovlašćen je za sastavljanje tehničke dokumentacije.</p> <p>Ova izjava se odnosi na proizvod na koji je stavljena CE oznaka.</p>
<p>Slovenščina</p> <p>Predmet deklaracije: Hitachi Vrtalno rušilno kladivo DH52ME, DH52MEY</p> <p>ES IZJAVA O SKLADNOSTI</p> <p>Po lastni odgovornosti objavljamo, da je izdelek v skladu s standardi ali dokumenti za standardizacijo EN60745-1, EN60745-2-6, EN55014-1, EN55014-2, EN61000-3-2 in EN61000-3-3 v skladu z direktivami 2004/108/ES in 2006/42/ES. Za izdelek je skladen tudi z direktivo RoHS 2011/65/EU.</p> <p>Direktor za evropske standarde podjetja Hitachi Koki Europe Ltd. je pooblaščen za sestavljanje tehničnih datotek.</p> <p>Deklaracija je označena na izdelku s pritrjeno CE oznako.</p>	<p>Hrvatski</p> <p>Predmet deklaracije: Hitachi Rotirajući čekić DH52ME, DH52MEY</p> <p>EC IZJAVA O SUKLADNOSTI</p> <p>Izjavljujemo s punom odgovornošću da je ovaj proizvod sukladan normama i dokumentima za standardizaciju EN60745-1, EN60745-2-6, EN55014-1, EN55014-2, EN61000-3-2 i EN61000-3-3 sukladno Direktivama 2004/108/EC i 2006/42/EC. Ovaj proizvod je također sukladan RoHS Direktivi 2011/65/EU.</p> <p>Direktor za evropske standarde u poduzeću Hitachi Koki Europe Ltd. ovlašten je za sastavljanje tehničke dokumentacije.</p> <p>Ova izjava se primjenjuje na proizvod na kojem je stavljena CE oznaka.</p>
<p>Slovenčina</p> <p>Predmet vyhlásenia: Hitachi Vrtacie kladivo DH52ME, DH52MEY</p> <p>VYHLÁSENIE O ZHODE - EC</p> <p>Týmto vyhlasujeme na našu vlastnú zodpovednosť že tento výrobok je v zhode s nasledujúcimi normami a dokumentmi normalizácie, EN60745-1, EN60745-2-6, EN55014-1, EN55014-2, EN61000-3-2 a EN61000-3-3 a v súlade so smernicami 2004/108/ES a 2006/42/ES. Tento výrobok vyhovuje tiež smernici RoHS č. 2011/65/EU.</p> <p>Za zostavenie technického súboru je zodpovedný manažér pre európske normy spoločnosti Hitachi Koki Europe Ltd.</p> <p>Toto vyhlásenie sa vzťahuje na výrobok označený značkou CE.</p>	<p>Український</p> <p>Предмет декларування: Hitachi Комбінований перфоратор DH52ME, DH52MEY</p> <p>ДЕКЛАРАЦІЯ ВІДПОВІДНОСТІ ЕС</p> <p>Ми декларуємо, що цей виріб відповідає стандартам або стандартизаційним документам EN60745-1, EN60745-2-6, EN55014-1, EN55014-2, EN61000-3-2 і EN61000-3-3 згідно Директив 2004/108/EC і 2006/42/EC. Цей виріб також відповідає Директиві про вміст небезпечних речовин 2011/65/EU.</p> <p>Менеджер Євростандартів з Hitachi Koki Europe Ltd. повноважений заповнити таблицю технічних характеристик.</p> <p>Ця декларація дійсна щодо виробу, маркованого CE.</p>
<p>Български</p> <p>Предмет на декларацията: Hitachi Перфоратор DH52ME, DH52MEY</p> <p>EO ДЕКЛАРАЦИЯ ЗА СЪОТВЕТСТВИЕ</p> <p>Ние декларираме на собствена отговорност, че продуктът е в съответствие със стандартите или стандартизиращи документи EN60745-1, EN60745-2-6, EN55014-1, EN55014-2, EN61000-3-2 и EN61000-3-3 съгласно Директиви 2004/108/EO и 2006/42/EO. Този продукт съответства, също така, на Директива RoHS 2011/65/EC.</p> <p>Мениджърът Европейски стандарти в Hitachi Koki Europe Ltd. е упълномощен за съставяне на техническото досие.</p> <p>Тази декларация е приложена за продуктите с прикрепена маркировка CE.</p>	<p>Русский</p> <p>Предмет декларирования: Hitachi Комбинированный перфоратор DH52ME, DH52MEY</p> <p>ДЕКЛАРАЦИЯ СООТВЕТСТВИЯ ЕС</p> <p>Мы с полной ответственностью заявляем, что данное изделие соответствует стандартам или документам стандартизации EN60745-1, EN60745-2-6, EN55014-1, EN55014-2, EN61000-3-2 и EN61000-3-3 согласно Директивам 2004/108/ЕС и 2006/42/ЕС. Данный продукт соответствует требованиям Директивы 2011/65/EU по ограничению на использование опасных веществ.</p> <p>Менеджер отдела европейских стандартов качества компании Hitachi Koki Europe Ltd. имеет право составлять технический файл.</p> <p>Данная декларация относится к изделиям, на которых имеется маркировка CE.</p>
<p>Hitachi Koki Europe Ltd. Clonsbaugh Business & Technology Park, Dublin 17, Ireland</p> <p>Representative office in Europe Hitachi Power Tools Europe GmbH Siemensring 34, 47877 Willich 1, F. R. Germany</p> <p>Head office in Japan Hitachi Koki Co., Ltd. Shinagawa Intercity Tower A, 15-1, Konan 2-chome, Minato-ku, Tokyo, Japan</p> <p> 27. 2. 2015</p> <p> John de Loughry European Standard Manager 27. 2. 2015</p> <p> A. Yoshida Vice-President & Director</p>	